



DYNAMIC IMAGE ANALYSIS

Measure materials from
2 to 135,000 microns

Patented 3D analysis

Wet & dry measurements

Over 30 morphological parameters



AGGREGATES



GLASS BEADS



3D PRINTING



PLASTICS



ABRASIVES



FOOD / AGRICULTURE



FERTILISER



PHARMACEUTICALS



CHEMICALS



METAL POWDERS



COATINGS



INDUSTRIAL MINERALS

Microtrac: Image Analysis Experts Since 1987

With more than 30 years at the forefront of technological advances in measuring material size and shape in real-time, Microtrac is the established leader in delivering innovative particle analysis solutions.

Dynamic image analysis is the most recent and advanced commercial particle characterisation technique. DIA characterises particles in motion by digitising photographs of each particle and storing them in an image file. Each particle is measured in real-time, while the software calculates morphological parameters based on the known size and location of the pixels in each image. DIA can measure either dry material or suspensions and emulsions. Unlike manual microscopy, DIA can automatically measure large, representative and statistically valid samples of particles in only a few minutes.

Microtrac's patented 3D technology utilises an innovated scheme of tracking particles. By tracking, the PartAn^{3D} obtains multiple images of each particle enabling our software to see the particles in many different orientations. This results in the most accurate measurements of length, width, and the third dimension, thickness. From these measurements, we are able to calculate more than 30 size and shape parameters.



Key elements of PartAn^{3D} system



How our patented 3D measurement works

Tracking is the key. The high speed, digital camera will take multiple images of each particle, showing it in all orientations. The PartAn^{3D} software will then measure length, width, thickness, perimeter, and area of the particle as it maps it in pixels.

Microtrac's Patented 3D Technology

PartAn Technology Differentiation - Morphological Parameters

More than 30 size and shape parameters enable researchers to experiment and learn more about their material than they thought possible. For QA / QC labs, engineers are able to define their product more specifically than before and set tighter specifications. They will realise improved final product quality and production efficiency.

Total List Microtrac Morphological Parameters

Size	Shape/Form	Surface Roughness	Other
Da	Sphericity	Convexity**	Transparency***
Dp	Circularity	Solidity**	Curvature
FLength	Roundness	Concavity**	
FWidth	Krumbein Roundness		
FThickness*	Extent		
ELength	Ellipse Ratio		
EWidth	W/L Aspect Ratio		
EThickness*	T/L Aspect Ratio*		
Area	L/T Ratio*		
Volume	L/W Ratio		
Perimeter	T/W Ratio*		
Surface Area	W/T Ratio*		
CHull Area	Ellipticity		
CHull Surface Area	Angularity		
Sieve*	Rectangularity*		
Cylinder Diameter*	Compactness		
Cylinder Length*			
Fiber Length			
Fiber Width			

* 3D only

** Surface measurements describe the smoothness of particles. Rough surfaces can create dust and poor flowability.

*** Transparency measures the light intensity passing through a particle to identify off-spec material.

Measure length, width, and thickness for more accurate data

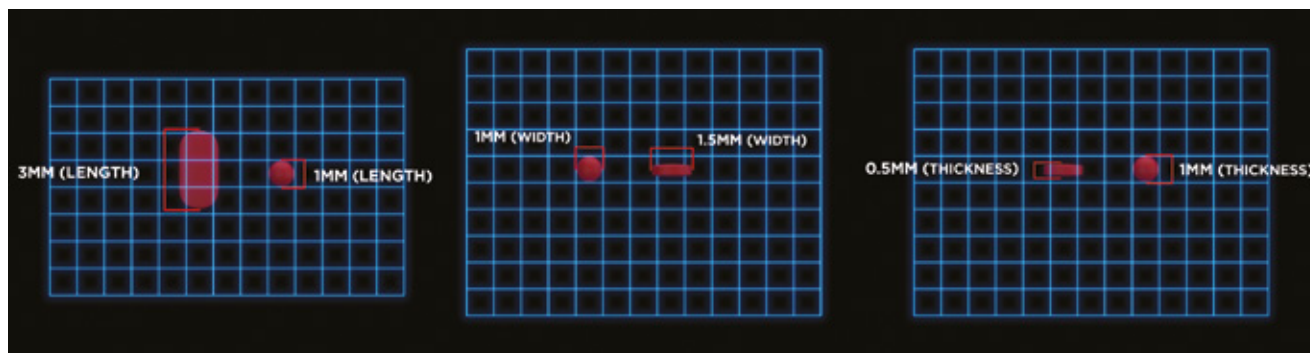

Exclusive 3D technology

- The only particle size analyser that tracks particles, using 3D particle measurement
- The 3D imaging technology and software are the same for PartAn^{3D} and PartAn^{3D} Maxi
- All three major particle axes length, width, and thickness are measured
- PartAn^{3D} is the only instrument that can provide shape ratios of thickness / width, width / thickness, length / thickness and thickness / length
- All tracked particles are stored in a library and can be recalculated to obtain any size and shape distribution
- The filter function in the SOP offers a customised result calculation and presentation
- The 3D tracking technology enables identification of the minimum-, maximum-, and average-values of size and shape of a single particle automatically

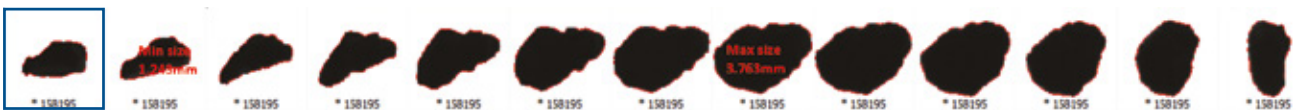

Above, particle #158195 has been imaged 13 times to provide a size of 2.451 mm, a maximum size of 3.763 mm (length), and a minimum size of 1.243 mm (thickness)

PartAn^{3D}

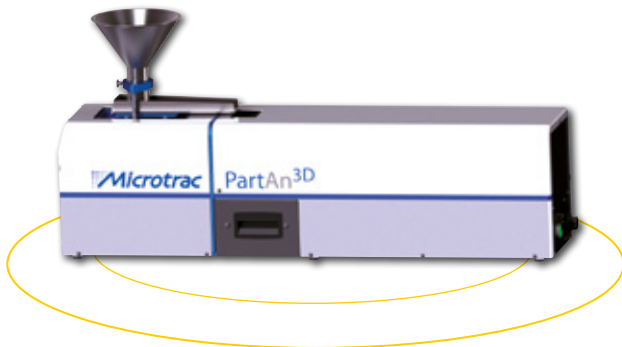

Bench-top 3D size and shape analyser

- Characterises over 40 morphological parameters
- Measurement of dry, free-flowing particles ranging in size from 22 µm to 35,000 µm
- Analyses more than 100 frames per second with our high-speed, high-resolution camera
- Key applications: Proppants (hydraulic fracturing), granular fertiliser, reflective glass beads, drug time release capsules, extrusions (granulation), abrasives

PartAn^{3D} Maxi

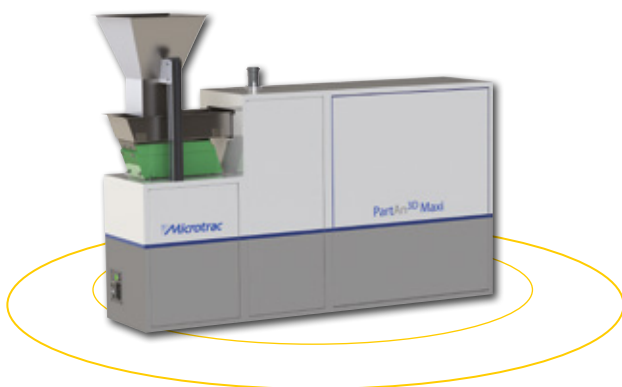

Large particle 3D size & shape analyser

- Characterises over 40 morphological parameters
- Measurement of dry particles ranging in size from 160 µm to 135,000 µm
- Analyses more than 100 frames per second with our high-speed, high-resolution camera
- Rugged and adaptable for any laboratory or pilot plant
- Key applications: Proppants (hydraulic fracturing), granular fertiliser, reflective glass beads, drug time release capsules, extrusions (granulation), abrasives, aggregates



Powerful, patented 3D measurement software provides users with unparalleled analysis capability

The filter function allows users to focus on areas of interest. With the filter function you can:

- Identify, isolate, and compare parameters of interest for further investigation and analysis
- Permanent set-up of a Standard Operating Procedures is ideal for multiple users, across multiple shifts
- All filters can be reported as individual distributions to provide a more detailed understanding of areas of interest during the analysis
- Allows exclusion of filters from measurement - only report needed information
- Easy to export to other software platforms

Understand the composition of your material with our classification function. One analysis in less than a minute can provide you with a detailed percentage breakdown of your material. Here is a sample breakdown of a glass bead sample:

- 45% “good beads”
- 35% “bad beads”
- 20% sand

Reporting: simple, powerful, flexible

- Comprehensive reporting for R&D and methods development
- Users can choose number of channels and channel widths
- Choose from more than 30 morphological parameters in 1 to 6 tabular columns
- Streamlined for at-a-glance QC “pass / fail”
- Image library querying

The power of on-line measurement

- Microtrac's line of on-line dynamic image analysers includes both wet and dry solutions
- Real-time measurements enable optimum control of production or quality control of final product
- Sampling systems are customised to fit any production line
- Robust design for long life and minimum maintenance
- Results integrated with DCS in control room
- Very sensitive to even small changes in size and shape distribution
- Gives operator immediate confirmation when changes are made to the process

PartAn^{3D} PRO



PartAn^{3D} Maxi PRO

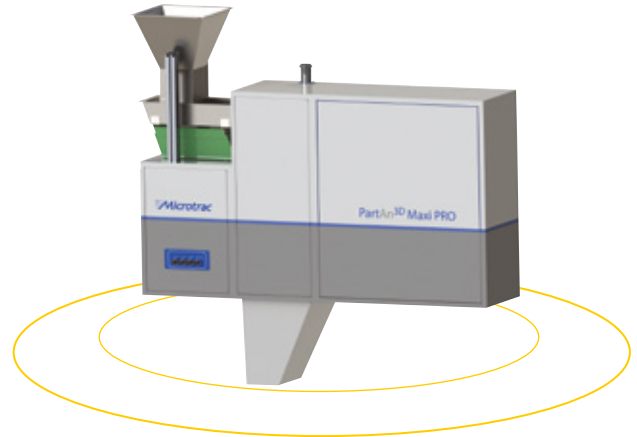

PartAn SI PRO



This liquid particle analyser is an on-line measuring system

PartAn SI PRO particle size and shape analyser for wet dispersions ranging in size from 2 µm to 2,000 µm. The PartAn SI PRO can be integrated into any process loop and features a proprietary sample extraction process that ensures optimal conditioning of your material.

Plus, the PartAn SI PRO sample volume requirement is scalable to fit your analysis needs.

The Microtrac Advantage

With over 30 years of experience in on-line particle size and shape measurements, Microtrac understands the needs of the process environment.

See what sets us apart from the competition:

- The Microtrac PRO series features a self-cleaning mechanism that utilises compressed air to ensure the optical chamber remains dust-free – reduces downtime and operator intervention
- Explosion-proof when needed
- The PRO series is engineered for ruggedness enabling it to handle the toughest environments
- This powerful tool enables process engineers to optimise the set of process parameters and easily detect deviations in product quality in real time

The PartAn PRO series cleanly integrates with third-party sample systems

One PartAn. Multiple Samplers. Endless Possibilities.

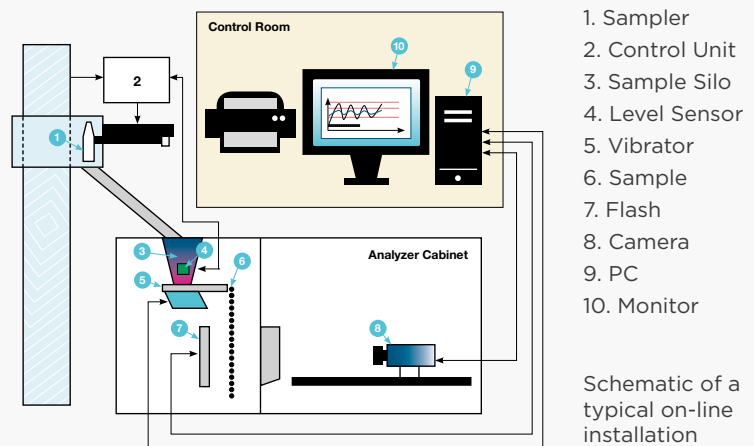

On-line measurement gives operators the ability to see process changes in real-time, enabling them to react immediately, resulting in maximum shipment of on-spec product.

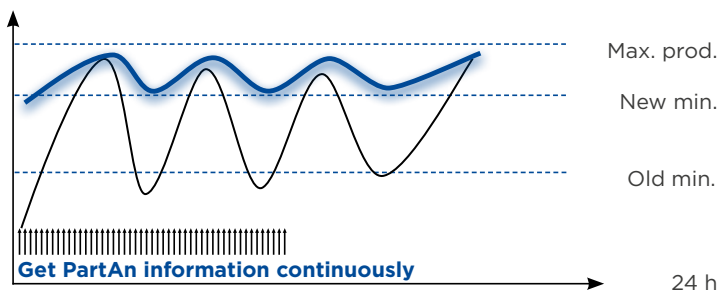

Depiction of process swing control – improved product quality

Deliver higher quality products with the PartAn PRO series

- Tailor made sampling solution for frequent representative sampling
- Reduce poor quality product returns
- Ensure top dollar for product you produce
- Increased production capacity

ROI is very quick. Contact us for estimates compared to sieves or other techniques.

See what a Microtrac PartAn PRO customer says about our solutions:

„The PartAn3D PRO is a very easy to use instrument and is more accurate and representative when measuring large amounts of material compared to using a small amount in a sieve. The instrument saves our operators a lot of valuable time because they are not manually running the instrument, which frees up their time to concentrate on other critical tasks.“

-Laboratory Engineer for a global material engineering company

Introducing the Sync

Microtrac's synchronous size and shape analyser, the Sync, integrates the world's leading laser diffraction technology with the world's leading dynamic image analysis technology – same bench, same sample, same run, same flow cell, same user interface. Users can now get their tried and true particle size distribution together with particle morphology in a single, easy to use graphical user interface.

Using our patented methodology, the Sync interrogates particles, wet or dry, with laser light while simultaneously a high-speed digital camera takes images. The data collected is processed by our FLEX software and presents the user with particle size and shape information. While the software is powerful, the graphical user interface is intuitive and easy to use. The Sync enables users to get more detailed information about their material than ever before and will quickly render size-only instrumentation outdated and incomplete.

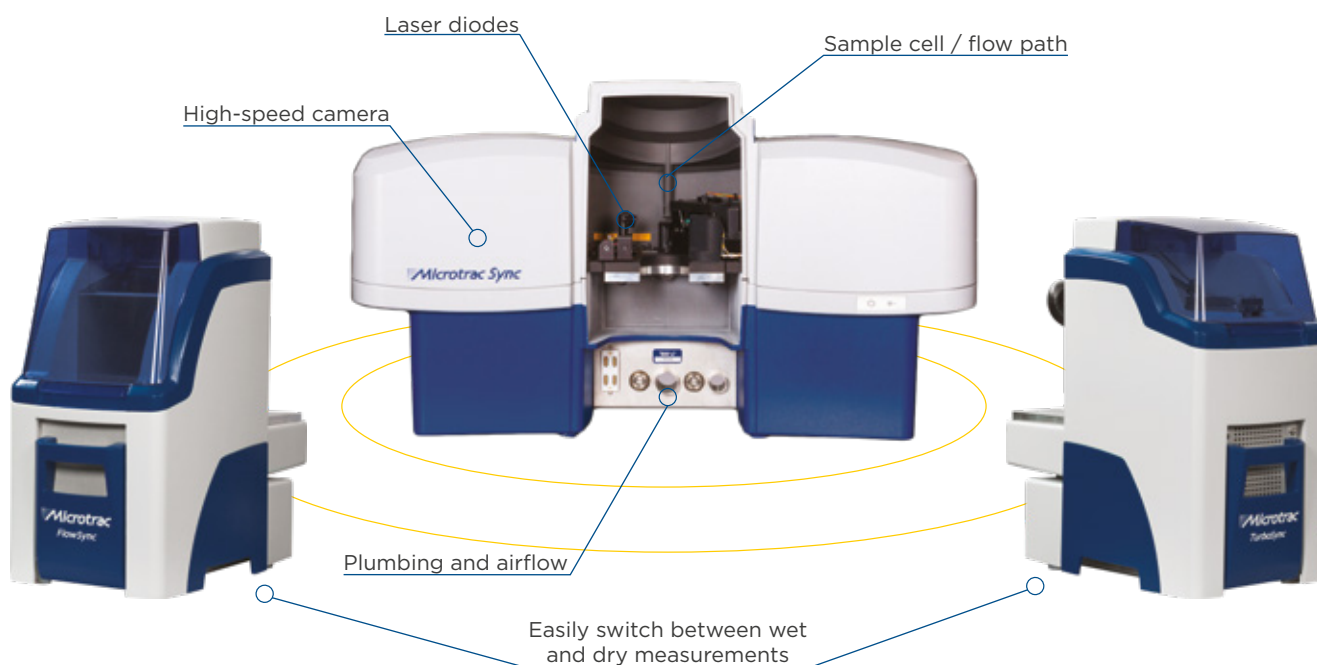

- Laser diffraction and image analysis integrated in one instrument
- Measurement capability from 0.01 to 4000 microns
- Measure over 30 size and shape parameters
- Easily switch between wet and dry measurements
- High and low concentrations
- Small bench footprint

Microtrac's TurboSync delivers a properly dispersed sample to the measuring cell allowing for consistent and repeatable particle size analyses of dry powders.

- Measurement time is typically 10 seconds with the TurboSync autoscan
- Sample volumes can be as small as 0.1 cc
- Compressed air and flow conditions settings allow the operator to achieve optimal dispersion usually associated with fluid dispersal systems for highly agglomerated materials such as alumina. Dispersion conditions can be fine-tuned for measurement of the most fragile materials

Wet particle size and shape analyser integrated with diffraction

- Whether your process requires agglomeration or you simply want to avoid it, now you can visually validate your material with the Microtrac S3500 SI
- Proven laser diffraction technology measures size distribution of particles ranging from $.01 \mu\text{m}$ to $2000 \mu\text{m}$, while the dynamic image analyser measures over 30 morphological parameters
- Sample recirculator has various speed settings and in-line sonication providing greater degree of flexibility for sample dispersion

PartAn SI



Microtrac's SI can be operated as a stand-alone unit with one of our dispersion devices, the SDC or USVR. The SI can be added right away when the diffraction system is installed, or at a later time as an upgrade.

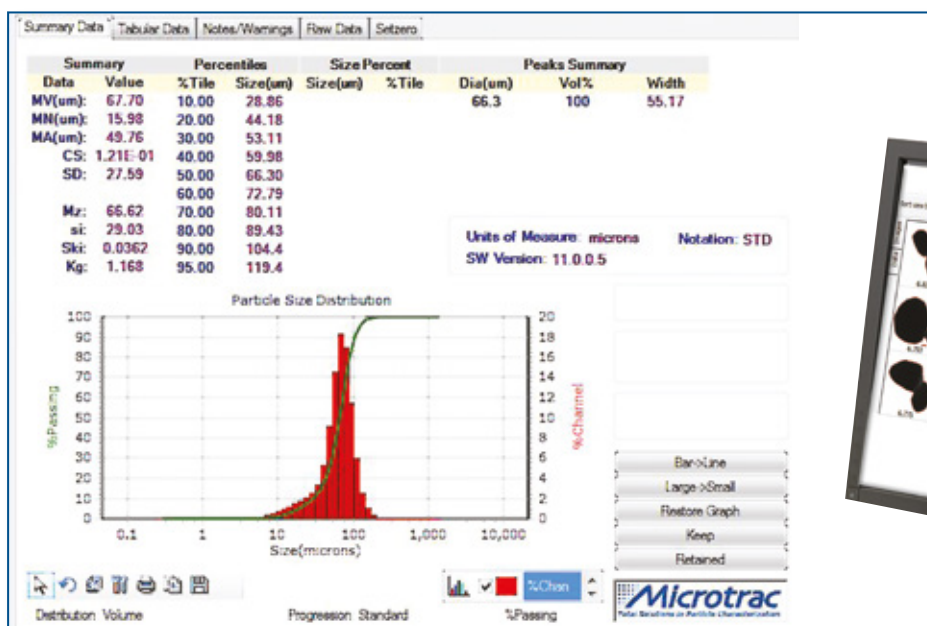
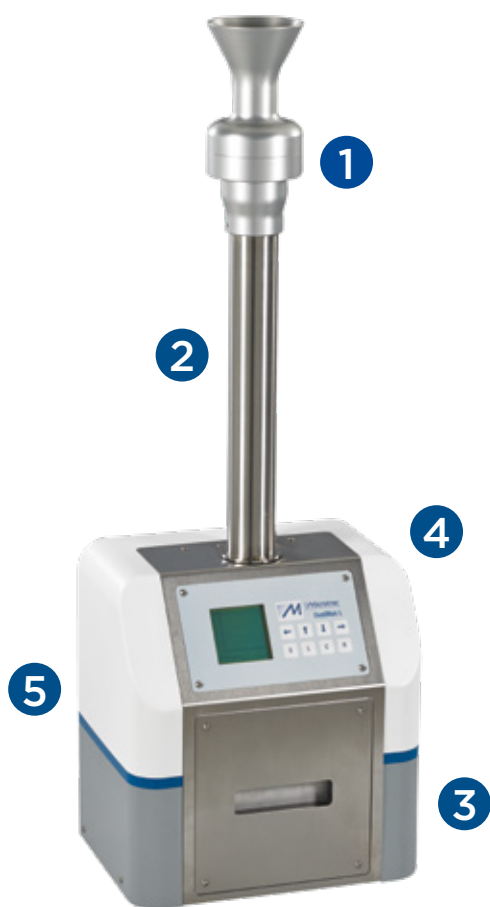

Image validation of agglomeration

DustMon Measurement Analyser



The DustMon measures the amount of dust in powder and granulates, determines the dust index, and calculates particle size distribution of the dust particles.

Microtrac's DustMon consists of a dosing control system (sample beaker [1] with a valve and a tube [2]), which is easily detachable for cleaning and transportation, a sample collector [3], a light source [4] and a detector [5].

The sample is poured into the sample beaker [1]. By starting the measurement, the valve opens and the sample drops down the tube [2] into the sample collector [3].

The dust generated in the sample collector will be measured by the detector [5] and the resulting dust index will be displayed.

Results

- Maximum dust concentration in % (0-100% of complete dust concentration)
- Dust concentration after 30 seconds
- Dust index (maximum and concentration after 30 seconds)

Microtrac's DustMon characterises the amount of dust in powders and granulates. It is our state-of-the-art system for dust measurement.

There are two system operating modes:

- Standalone (no PC control)
- Control via Windows PC

Selected features of the DustMon Windows software:

- Ability to save results including sample information, time and date of measurements

- Data export to an external database such as LIMS or Excel
- Ability to set up and configure the DustMon for various applications including more advanced settings for R&D
- Graphical display of measurements with the ability to overlay historical data to analyse and compare

DustMon: Additional Features



- Robust design
- Temperature range from 0°C to +40°C
- Completely sealed sample beaker
- Consistent results between multiple systems
- Long-life light source (min. 100.000 hours)
- Easy to handle, easy to clean
- Analysis based on the CIPAC MT 171 method
- USB interface

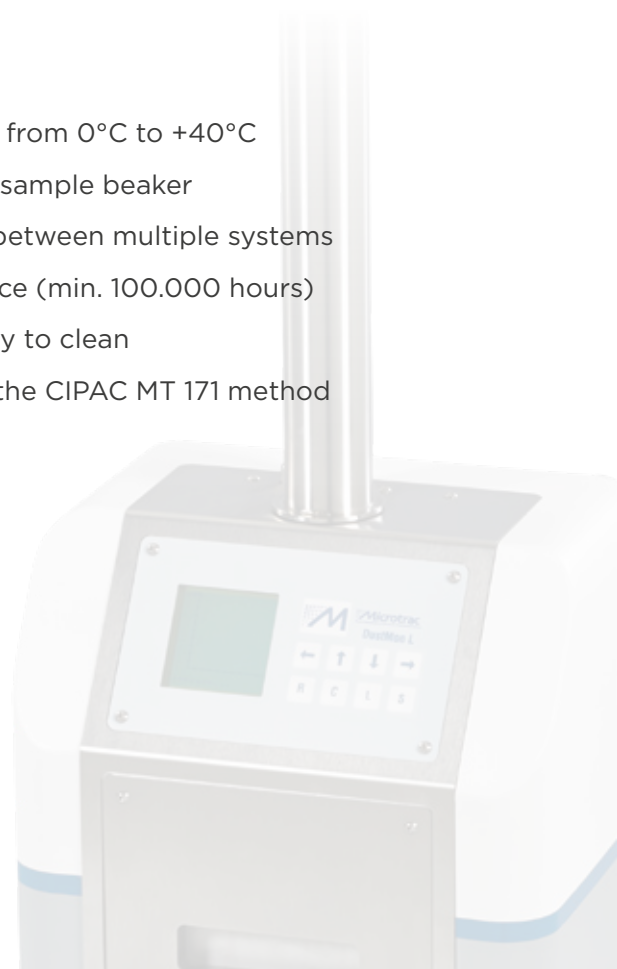

Sample result from the DustMon system

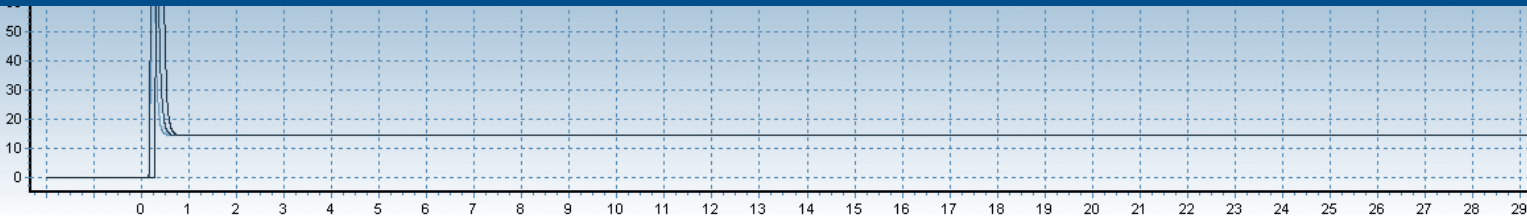
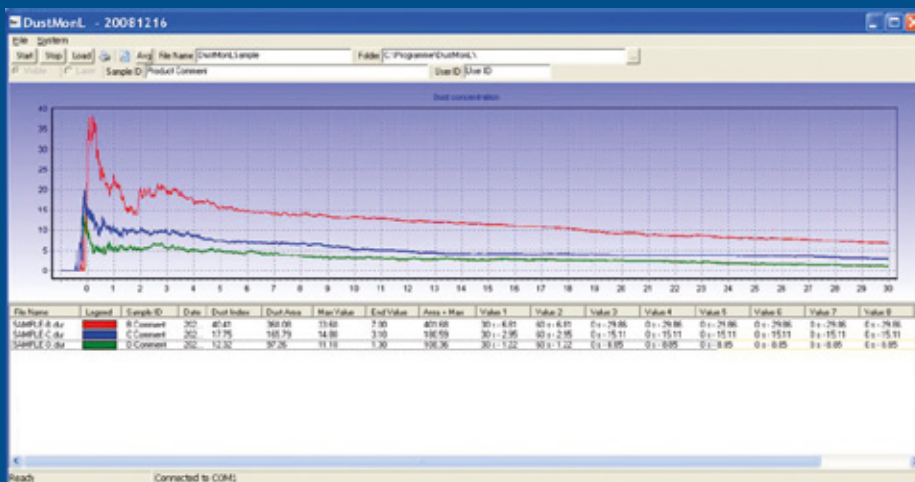

Dynamic Image Analysers

Microtrac's line of dynamic imaging analysers are available in a variety of measurement ranges so that you are better matched with the best system for your specific application.

Microtrac's DIA instruments can measure particles from 2 to 135,000 microns in size.

All Microtrac DIA analysers are compliant with ISO 13322-2.

	PartAn ^{3D} / PRO	PartAn ^{3D} Maxi / PRO	PartAn SI / PRO	Sync	DustMon
					
Sample medium	Dry	Dry	Wet	Wet & dry	Dry
Detection range	22 – 35,000 µm	160 – 135,000 µm	2 µm – 2,000 µm	.2 – 4,000 µm (dry) .01 – 2,800 µm (wet)	
Number of morphological parameters of your material including 3D	40	40	>30	>30	
Complies with ISO 13322-2	✓	✓	✓	✓	
Process version	✓	✓	✓		
					

Subject to technical modifications and errors - Copyright © by Microtrac MRB - 980.2024/E-07-2021

